

Analysis and Characterization of the Condenser of a Small Scale Solar Air Conditioning Unit

José A. Fuentes Meléndez
 Mechanical Engineering
 Rafael Salgado, PhD
 Department of Mechanical Engineering
 Polytechnic University of Puerto Rico

Abstract - This work is intended to show the characterization of a flat plate heat exchanger used as the condenser of a small scale solar air conditioning system and the recommendations for future studies. Also show flat plate heat exchanger geometric characteristics and analysis considerations.

Key terms- Condenser, Plate Heat Exchanger, Refrigeration Solution, Solar Air Conditioning

INTRODUCTION

Costs associated with energy production have grown in the last few years [1]. And Renewable energies are gaining popularity from this fact and a potential source to lower energy costs is the solar energy. In Puerto Rico, the household device that consumes the most energy is the air conditioning unit. Thus, a great part of the energy produced in the island is to satisfy the demand for comfort. From this, solar air conditioning is one of the alternatives to study and develop.

In a simple ideal standard refrigeration cycle, the system consists of a condenser, an expansion valve, an evaporator and a compressor (Figure 1).

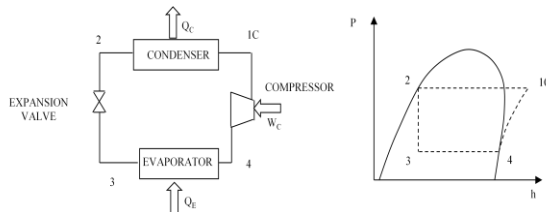

Figure 1
Simple Ideal Standard Refrigeration Cycle

Here the super heated refrigerant is compressed to a high pressure and temperature where latent heat is exchanged and a phase change takes place in the condenser at constant pressure to saturation conditions. Next the refrigerant flows through the

expansion valve, lowering the refrigerant pressure at a constant enthalpy process. Then refrigerant flows through the evaporator in which heat is absorbed, producing a phase change up to saturated vapor conditions. Finally, the gas is compressed, and the cycle continues.

In solar air conditioning, some systems exist for commercial and industrial purpose using absorption and desiccant technologies. Only absorption technology is considered in this work. The Absorption chillers used in solar cooling facilities are large in size due to the necessary heat transfer surface area. In order to make more compact units, plate heat exchangers are used. In a simple ideal standard absorption refrigeration cycle, the mechanical compressor is replaced by thermal compressor (Figure 2).

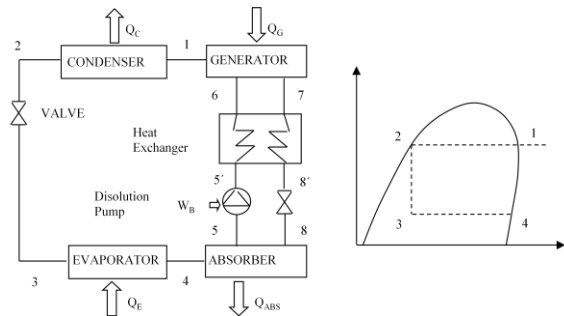

Figure 2
Simple Ideal Standard Absorption Cycle

This thermal compressor consists of a generator, a heat exchanger, an expansion valve, an absorber and a pump, in which the refrigerant flows at vacuum pressures. Here, typically a Lithium Bromide-Water (LiBr-H₂O) or Water- Ammonia solution (H₂O-NH₃-) is used. The solution consists of an absorber and a refrigerant. In the case of LiBr-H₂O solution, the absorber is the LiBr salt and the refrigerant is Water. The salt has great affinity for water in the form of vapor. The same happens in

the H_2O-NH_3 solution with the difference that water is the absorber and ammonia the refrigerant. In the generator heat is added causing a rise in temperature of the solution and the water to boil. This steam goes to the simple refrigeration cycle (flows through the condenser, the expansion valve and the evaporator), while the salt undergoes the other cycle in the thermal compressor. The Concentrated solution (concentrated in salt) flows from the generator to a heat exchanger in which heat is transfer from the concentrated to the diluted solution (see Figure 2). Then the concentrated solution goes through an expansion valve, diminishing its pressure to the absorber pressure, which has the same pressure of the evaporator. In the absorber, steam generated in the evaporator from the standard refrigeration cycle, is absorbed by the solution where it gets diluted and pumped back to the generator where the cycle continues.

In solar air conditioning, the generator receives its heat input from solar collectors and may include a storage device to provide hot water in order to boil off refrigerant from the solution. The absorber and condenser are cooled by means of a cooling tower. Figure 3 shows part of a prototype of a small scale solar air conditioning unit which is used in this research.

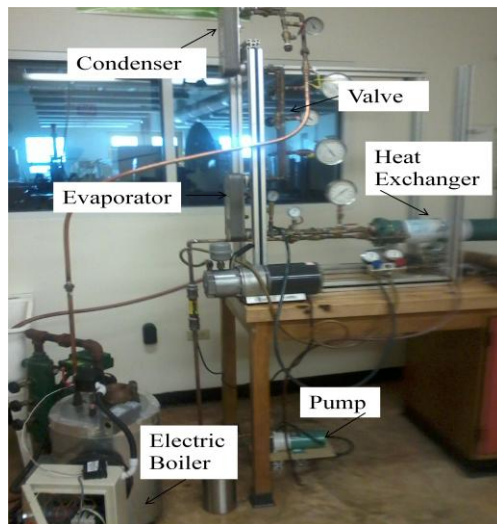

Figure 3
Study System

In this system, the generator is substituted by an electric boiler to provide the require steam for

characterization purposes. Two plate heat exchanger are used, one for the function of the condenser and the other for the function of the evaporator. A counter flow heat exchanger is provided to condense the vapor from the evaporator, and a low flow pump returns the condensate to the boiler. Cold water from mains flows through all heat exchangers for re cooling purposes.

FLAT PLATE HEAT EXCHANGER ANALYSIS

Flat plate heat exchanger consists of several corrugated metal plates that are joined together by means of gaskets or brazed, that form interconnected conduits in which fluid flows. The two major corrugate forms are intermating and chevron [2, 3, 4]. It is necessary to introduce important parameters for the analysis.

Plate Geometry

For analysis of plate heat exchangers, different geometric parameters are defined. The geometry of the plate is determined by the size and form of the corrugation. The most common plate corrugate form is the chevron. For this type, the corrugation can be identified by the chevron angle with respect to the vertical, ϕ , the chevron angle with respect to the horizontal, β , the corrugation depth, b , space between corrugation, Λ , and the curvature radius, R (see figure 4).

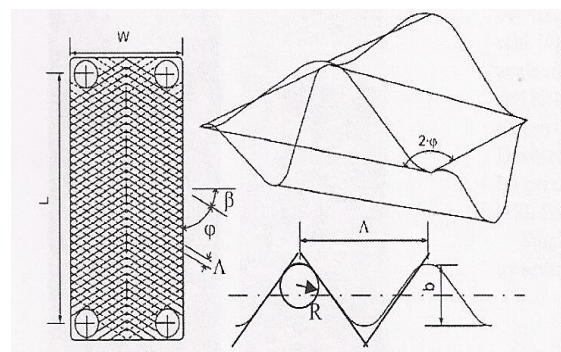

Figure 4
Plate Geometry of Chevron Corrugation [3]

The mean channel gap or corrugation depth b , given by "(1)" [2], is defined as channel pitch, p , minus plate thickness, t

$$b = p - t \quad (1)$$

The flow channel area “(2)” is

$$A_c = b \times w \quad (2)$$

The projected area, A “(3)” is

$$A = N_{usefull} \times a = N_{usefull} \times L \times W \quad (3)$$

Where, $N_{usefull}$ is the number of useful plates; a projected area of one plate; L is the height of the plate in the flow direction; W is the width of the plate.

THE OVERALL HEAT TRANSFER COEFFICIENT

The energy balance equation is used to find the overall heat transfer coefficient. Equation “(4)” express that the heat gained by the cold fluid, \dot{Q}_c , is equal to the heat loss by the hot fluid, \dot{Q}_h ,

$$\dot{Q}_h = \dot{Q}_c \quad (4)$$

The heat gain, \dot{Q} , can also be express by “(5)” as

$$\dot{Q} = \dot{m}C_p(T_o - T_i) \quad (5)$$

Where, T_o is the outlet temperature of the fluid and T_i is the inlet temperature of the fluid, \dot{m} is the fluid mass flow rate, and C_p is the fluid specific heat.

The heat gain “(6)” and the overall heat transfer coefficient can be obtained by the Log Mean Temperature Difference “(7)”

$$\dot{Q} = (UA)F(T_{LMTD}) \quad (6)$$

$$T_{LMTD} = \frac{\Delta T_2 - \Delta T_1}{\ln \left[\frac{\Delta T_2}{\Delta T_1} \right]} \quad (7)$$

Where for counter flow, see figure 5, ΔT_2 and ΔT_1 are defined by “(8)”and “(9)”

$$\Delta T_2 = T_{o,h} - T_{i,c} \quad (8)$$

$$\Delta T_1 = T_{i,h} - T_{o,c} \quad (9)$$

And U is the overall heat transfer coefficient, A is the projected area multiplied by the number of plates or heat transfer area, and F is the correction coefficient of the T_{LMTD} . The correction coefficient

is a function of the heat exchanger geometry and fluid temperatures [4, 5, 6].

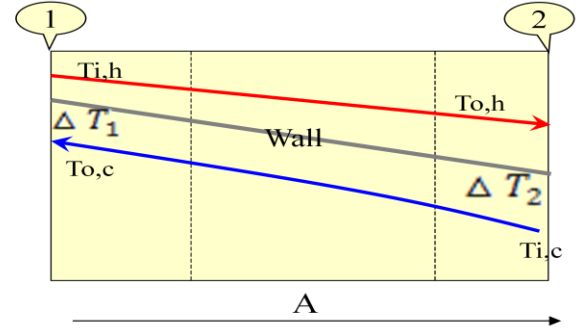

Figure 5
Counter Flow Temperature Distribution

In order to find the correction factor, F , is necessary to define the relation between capacities (R), and effectiveness (P), “(10)”and “(11)” that gives us the information about the thermal capacities of the fluids and the effectiveness of the heat exchanger [5].

$$R = \frac{T_{i,h} - T_{o,h}}{T_{o,c} - T_{i,c}} \quad (10)$$

$$P = \frac{T_{o,c} - T_{i,c}}{T_{i,h} - T_{o,h}} \quad (11)$$

The overall heat transfer coefficient can be calculated by “(12)” [5, 6]

$$U = \frac{\dot{m}C_p(T_o - T_i)}{AF(T_{LMTD})} \quad (12)$$

The overall heat transfer coefficient can be also calculated by “(13)” or “(14)”,

$$\frac{1}{U} = \left(\frac{1}{h_c} + \frac{e}{K_m} + \frac{1}{h_h} + R_{ce} + R_{ci} \right) \quad (13)$$

$$U = \frac{1}{\frac{1}{h_c} + \frac{e}{K_m} + \frac{1}{h_h} + R_{ce} + R_{ci}} \quad (14)$$

Where U is the overall heat transfer coefficient, h_c and h_h are the hot and cool convection coefficient, K_m is the thermal conductivity of the material, e is the material thickness, R_{ce} and R_{ci} are the thermal resistance due to film contamination. If the heat exchanger is new, the film contamination resistance can be neglected.

The velocity per channel, v , can be calculated by “(15)” taking in consideration the number of

useful plates (the exterior plates are not consider because they transfer heat in one face only), $N_{usefull}$ given by “(16)”, the number of plates, N , the number of channels “(17)”, and the fluid density, ρ ,

$$v = \frac{\frac{m}{n^o \text{ channels}}}{\rho \times b \times w} \quad (15)$$

$$N_{usefull} = N - 2 \quad (16)$$

$$n^o \text{ channels} = N_{usefull} - 1 \quad (17)$$

The Nusselt “(18)”, Reynolds “(19)” and Prandalt number “(20)” are

$$Nu = C \times Pr^n \times Re^m \quad (18)$$

$$Re = \frac{v \times l_c \times \rho}{\mu} \quad (19)$$

$$Pr = \frac{\mu \times C_p}{k} \quad (20)$$

$$l_c = 2 \times b \quad (21)$$

The values of n , m and C depends on flow characteristics (laminar or turbulent), and the properties of the fluids are find by the mean temperature. k is the fluid conductivity, l_c is the characteristic length of the channel “(21)” derived from “(22)”

$$l_c = \frac{4 \times S_c}{P_c} = \frac{4 \times b \times w}{2 \times (b+w)} \cong \frac{4 \times b \times w}{2 \times w} = 2 \times b \quad (22)$$

Where S_c is the channel transversal section, P_c is the perimeter of the channel section, b is the space between channels or plates, w is the plate width and b much less than w ($b \ll \ll \ll w$).

For turbulent flow an expression for Nusselt number is “(23)”

$$Nu = C \times Pr^m \times \quad (23)$$

The convection coefficient [5,6] for each fluid can be finds by “(24)” and “(25)”

$$Nu = \frac{h \times l_c}{k} \quad (24)$$

or

$$h = \frac{Nu \times k}{l_c} = \frac{C \times Pr^m \times Re^a \times k}{l_c} \quad (25)$$

then

$$\frac{1}{U} = \left[\frac{1}{\left(\frac{C Pr^m Re^a k}{l_c} \right)_c} + \frac{e}{K_m} + \frac{1}{\left(\frac{C Pr^m Re^a k}{l_c} \right)_h} \right] \quad (26)$$

The Modified Wilson Plot Method

The Wilson plot method was used for tube and shell heat exchanger, but modify for flat plate heat exchanger in order to determine de overall heat transfer coefficient by experimental results. The method is describes as fallow.

The equation used is “(27)”

$$\frac{1}{U} = \left[\frac{1}{\left(\frac{C Pr^m Re^a k}{l_c} \right)_c} + \frac{1}{\left(\frac{C Pr^m Re^a k}{l_c} \right)_h} \right] \quad (27)$$

Assuming that conduction resistance, $\frac{e}{K_m}$, is small compare with the convection resistances. Then multiply the equation by $\left(\frac{C Pr^m Re^a k}{l_c} \right)_c$ and rearrange yield in “(28)”.

$$\frac{1}{U} * \frac{C Pr^m Re^a k_c}{l_c} = \frac{1}{C_c} + \frac{1}{C_f} * \frac{C Pr^m Re^a k_c}{Pr_h^m Re_h^a k_h} \quad (28)$$

Assuming an initial value for a with a value of $m=1/3$ is possible to find the values of C_c and C_h , because this equation form of a line equation “(29)”.

$$y = \frac{1}{C_c} + \frac{1}{C_h} * x \quad (29)$$

In order to make that the values to converge the initial equation is manipulated. The term of convection coefficient of the cold side, is added to the term of the overall heat transfer coefficient, result in “(30)”.

$$\frac{1}{U} - \frac{l_c}{C_c Pr_c^m Re_c^a k_c} = \frac{l_c}{C_h Pr_h^m Re_h^a k_h} \quad (30)$$

Then multiply both sides with $\frac{Pr_h^m k_h}{l_c}$ gives “(31)”

$$\left(\frac{1}{U} - \frac{l_c}{C_c Pr_c^m Re_c^a k_c} \right) * \frac{Pr_h^m k_h}{l_c} = \frac{1}{C_h Re_h^a} \quad (31)$$

And taking the inverse gives “(32)”

$$\frac{1}{\left(\frac{1}{U} - \frac{l_c}{C_c Pr_c^m Re_c^a k_c} \right) * \frac{Pr_h^m k_h}{l_c}} = C_h Re_h^a \quad (32)$$

Then apply the natural logarithm gives “(33)”

$$\ln \left[\frac{1}{\left(\frac{1}{U} \frac{l_c}{C_c Pr_c^m Re_c^a k_c} \right)^* \frac{Pr_h^m k_h}{l_c}} \right] = \ln(C_h Re_h^a) \quad (33)$$

Or “(34)”

$$\ln \left[\frac{1}{\left(\frac{1}{U} \frac{l_c}{C_c Pr_c^m Re_c^a k_c} \right)^* \frac{Pr_h^m k_h}{l_c}} \right] = \ln(C_h) + a * \ln(Re_h) \quad (34)$$

The form is a line equation like “(35)”.

$$y = \ln(C_h) + a * x \quad (35)$$

The values obtained for C_c and C_h are used in this new equation and a new value of a is obtain. This new value of a is used in the first equation and the process is repeated until the value converge.

PROCEDURE

First, all the components should be connected by copper tubing and fittings and welded together with tin and copper alloy (97/3).

Second, in the water circuit, water is allowed to flow through the system in order to check for leaks, using water hose form a hose bib to the inlet of the heat exchanger and outlet of the condenser circuit.

Third, the refrigerant circuit is tested, in which steam is generated. Compress air is allowed to enter to the circuit until it reaches 80psig of pressure. With a solution of soap and water, all the fittings are checked for bubble formation which indicates a leak.

Once the steam circuit is checked, it is subjected to vacuum. When no vacuum pressure is lost, the machine is ready to run and make the cooling process. Water is allowed to flow from a hose bib to the inlet of the electric generator and wait until the required level is reached. Then the inlet valve is close. The electric generator is turned on. When steam is generated, the steam service valve is open allow to flow through the circuit.

The expansion valve is close when the boiler is turned on. When the pressure of the boiler, start to rise, the expansion valve is opened, allowing the

condensate to flow. Next, when condensate flows from the heat exchanger, the pump is turn on allowing to maintain a low pressure side form the outlet of the expansion valve to the inlet of the pump. The expansion valve is open or close until a steady state condition is reach.

A data acquisition is used (see figure 6) to take measurements of two points of pressure in the vacuum side before and after the expansion valve with pressure transducers, and eight points of temperature at the inlet and outlet of each circuit on each plate heat exchangers through the use of thermocouples type T. It takes data every five seconds and makes an average every minute. This average is considered for the analysis. A flow meter measure the flow of water.

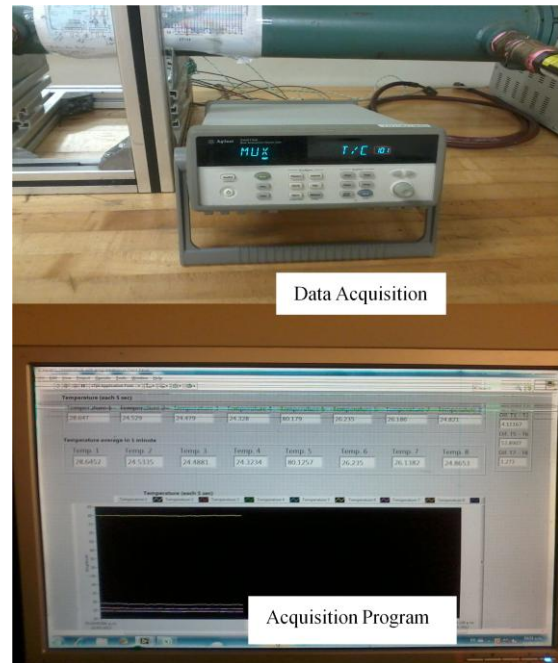

Figure 6
Data Acquisition Equipment and Program Used

ANALYSIS

The condenser and the evaporator are flat plate heat exchangers. The two circuits operate at different pressures and temperatures (the water circuit that flows through the heat exchanger, evaporator and condenser operates at normal pressure, while the steam circuit operates at vacuum pressures) in counter flow (see figure 5).

Due to the lack of information of the heat exchanger geometry, a simple energy analysis will be performs.

The assumptions for the analysis of flat plate heat exchangers [6] are:

- The heat exchanger operates at steady state conditions
- The global heat transfer coefficient is constant through the length of the heat exchanger. This not true since the properties of the fluids change with temperature, but for simplify, and that we don't know the temperature of the fluid in each point, the properties are evaluated at the mean temperature of inlet and outlet.
- The temperature and velocities are uniform along the channel
- There is not heat transfer in a long the fluid direction.
- The each mass flow rate are spread equally between all channels

The heat gain by the cold fluid is given by “(36)”

$$\dot{Q}_c = \dot{m}_c C_{pc} (T_{o,c} - T_{i,c}) \quad (36)$$

Where \dot{Q}_c is the heat flow gain by the cold fluid, \dot{m}_c is the mass flow rate of the cold fluid, C_{pc} is the specific heat of the cold fluid, $T_{o,c}$ is the cold fluid outlet temperature, $T_{i,c}$ is the cold fluid inlet temperature.

The heat loss by the hot fluid is given by “(37)”

$$\dot{Q}_h = \dot{m}_h C_{ph} (T_{i,h} - T_{o,h}) \quad (37)$$

Where \dot{Q}_h is the heat flow loss by the hot fluid, \dot{m}_h is the mass flow rate of the hot fluid, C_{ph} is the specific heat of the hot fluid, $T_{o,h}$ is the hot fluid outlet temperature, $T_{i,h}$ is the hot fluid inlet temperature.

The energy transfer from the hot fluid to the cold fluid is given by an energy balance in “(38)”, therefore

$$\dot{Q}_h = \dot{Q}_c \quad (38)$$

The thermal efficiency is defined as the actual

heat exchange over the maximum possible heat that the fluids could be exchange, and for a parallel flow, for hot fluid is “(39)”, η_h , and cold fluid is “(40)”, η_c ,

$$\eta_h = \frac{T_{i,h} - T_{o,h}}{T_{i,h} - T_{i,c}} \times 100\% \quad (39)$$

$$\eta_c = \frac{T_{o,c} - T_{i,c}}{T_{i,h} - T_{i,c}} \times 100\% \quad (40)$$

The effectiveness, ϵ , of the heat exchanger is given by “(41)”

$$\epsilon = \frac{\dot{Q}_h}{\dot{Q}_{max}} = \frac{\dot{Q}_c}{\dot{Q}_{max}} \quad (41)$$

The maximum heat transfer rate, \dot{Q}_{max} , given by “(42)” is the product of the minimum product of the mass flow rate by its specific heat for the cold or hot fluid and the maximum temperature range, that is, the hot fluid inlet temperature and the cold fluid inlet temperature.

$$\dot{Q}_{max} = \min(\dot{m}_h C_p, \dot{m}_c C_p) (T_{i,h} - T_{i,c}) \quad (42)$$

The heat gained by the cold fluid in the condenser can also be calculated by “(43)” [7].

$$\dot{Q}_c = \dot{m}_c h_{fg}^* \quad (43)$$

Where h_{fg}^* is the modified latent heat of vaporization defined by “(44)”.

$$h_{fg}^* = h_{fg} + 0.68 C_{pl} (T_{sat} - T_s) \quad (44)$$

And C_{pl} is the specific heat of the liquid at the average film temperature, T_{sat} is the saturation temperature, T_s is the plate surface temperature that can be taken as the mean temperature of the inlet and outlet of the fluid.

The properties of the fluid should be evaluates at the film temperature which is the average temperature of the liquid given by “(45)”.

$$T_f = \frac{(T_{sat} - T_s)}{2} \quad (45)$$

The average heat transfer coefficient for vertical plates and for $Re < 30$ is defined by “(46)”.

$$h_{vert} = 0.943 \left[\frac{g \rho_l (\rho_l - \rho_v) h_{fg}^* k_l^3}{\mu_l (T_{sat} - T_s) L} \right]^{1/4} \quad (46)$$

This can also be approximate by “(47)”

$$h_{vert} \cong 1.47k_l Re^{-1/3} \left(\frac{g}{\nu_l^2}\right)^{1/3} \quad (47)$$

Where g is the gravitational acceleration [m/s²], ρ_l , ρ_v are the density of the liquid and vapor [kg/m³], μ_l dynamic viscosity of liquid [kg/m*s], h_{fg}^* the modified latent heat of vaporization [J/kg], k_l is the thermal conductivity of the fluid [W/m*°C], L is the height of the vertical plate [m], T_s is the surface temperature [°C], T_{sat} is the saturation temperature of the condensing fluid [°C],

The total heat transfer is given by “(48)” using “(49)”

$$Q = (UA)F(T_{LMTD}) \quad (48)$$

$$T_{LMTD} = \frac{\Delta T_2 - \Delta T_1}{\ln\left[\frac{\Delta T_2}{\Delta T_1}\right]} \quad (49)$$

Where for counter flow, ΔT_1 and ΔT_2 are given by “(50)” and “(51)”.

$$\Delta T_1 = T_{i,h} - T_{o,c} \quad (50)$$

$$\Delta T_2 = T_{o,h} - T_{i,c} \quad (51)$$

Where U is the overall heat transfer coefficient, A is the heat transfer area, and F is the correction coefficient. The correction coefficient is a function of the heat exchanger geometry and fluid temperatures.

The Reynolds Number can be finds by “(52)”

$$Re = \frac{4\dot{Q}_{cond}}{p\mu_l h_{fg}^*} = \frac{4Ah(T_{sat} - T_s)}{p\mu_l h_{fg}^*} \quad (52)$$

This can also be approximate by “(53)”

$$Re = \frac{4g}{3\nu_l^2} \left(\frac{k_l}{3h_{vert}/4}\right)^3 \quad (53)$$

RESULTS

The system was tested at 8 l/min in the cooling water side and in the vapor side a high pressure (absolute) of 70KPa and a low pressure of 5KPa. The temperature of the water leaving the condenser was kept at an approximately 30 °C. Figure 7 shows the temperature distribution during data collection.

The average temperature computed after 3 hours of data collection is presented in Table1 at the near integer number. The water condenser outlet

and inlet temperatures are T_{wco} and T_{wci} respectively; the water evaporator outlet and inlet temperatures are T_{weo} and T_{wei} respectively. The vapor condenser inlet and outlet temperatures are T_{sci} and T_{sco} respectively; the vapor evaporator inlet and outlet temperatures are T_{sei} and T_{seo} respectively.

The properties of the vapor are evaluated at the average fluid temperature $(T_{sci} + T_{sco})/2 = 52$ °C and the water are evaluated at 27 °C (see Table 2). The vapor is assumed to be saturated.

After obtain all fluids properties, the calculation of the overall heat transfer coefficient is perform. Once obtain the condenser heat flow, and the modified latent heat of vaporization, h_{fg}^* , the mass flow rate of the vapor can be calculated by an energy balance. Then log mean temperature difference, is calculated and the UA can be obtain.

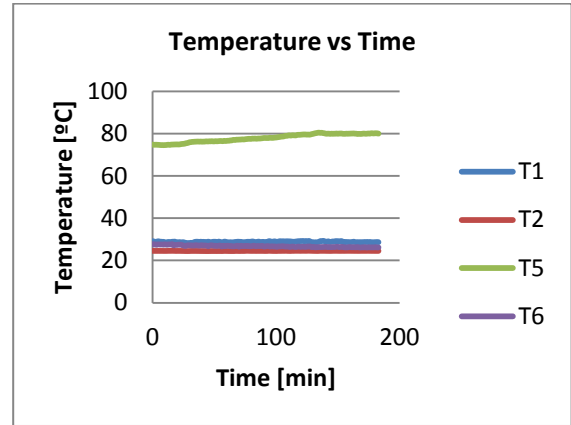

Figure 7

Temperature Distribution Versus Time

Table 1
Average Temperatures Register

Location	Thermocouple	Average[°C]
T_{wco}	T1	29
T_{wci}	T2	25
T_{weo}	T3	24.5
T_{wei}	T4	24.3
T_{sci}	T5	78
T_{sco}	T6	26
T_{sei}	T7	26.6
T_{seo}	T8	25

The mass flow of the vapor side is assumed to be

equally distributed along the channels of the circuit B of the heat exchanger, like the mass flow of the water on the circuit A (see figure 8). For this heat exchanger, the circuit B has more volume than circuit A. The thickness of each plate is measure with a micrometer, giving $t=1.59\text{mm}$ and the space between plates, $b=1.5875\text{mm}$. The Length, L , and width of the plates, W , are found in the heat exchanger specification: $L=0.253\text{m}$, $W=0.0686\text{m}$.

Table 2
Properties of Vapor at 78 °C and at Film Temperature of Water and Vapor [7]

T_f	52	78	27	°C
T_{sat}	52	78	27	°C
ρ_l	985.2	973	997	[kg/m ³]
ρ_v	0.1045	0.2729	0.0260	[kg/m ³]
h_{fg}	2378	2314	2430	[KJ/kg]
C_{pl}	4182	4195	4179	[J/kg*K]
k_l	0.646	0.669	0.610	[W/m* K]
μ_l	3.48E-04	3.64E-04	8.54E-04	[kg/m*s]

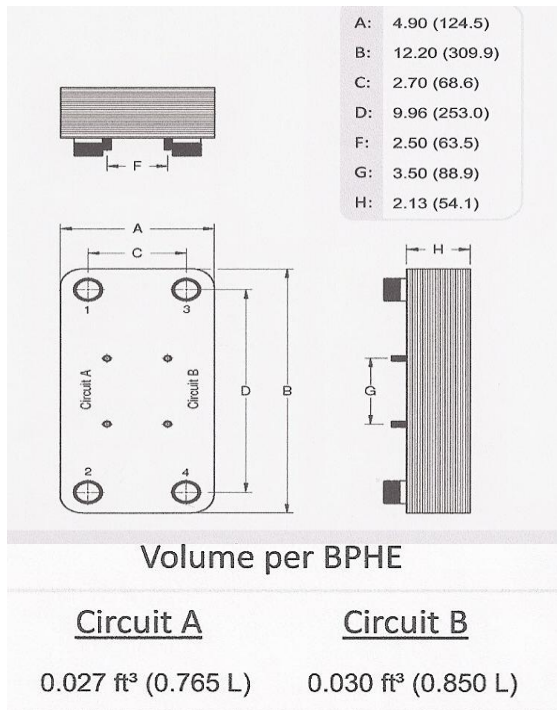

Figure 8
Heat Exchanger Dimensions and Circuit Distribution.
Dimension Shown are in [in(mm)] [9].

There are $N=21$ plates, but useful are 19, that gives 10 channels for vapor and 9 channels for

water.

The surface area, given by “(54)”, and the transfer area, given by “(55)”

$$As = L * W = 0.1736m^2 \quad (54)$$

$$A = 19 * As = 0.3298m^2 \quad (55)$$

The channel area is given by “(56)”

$$Ac = b * W = 0.0011m^2 \quad (56)$$

With this areas, the Overall Heat Transfer Coefficient, U , and the Reynolds Number, Re , can be computed and therefore the average condensation vertical convective coefficient, h_{vert} , also can be obtained. With h_{vert} and U , the water side convective coefficient can be obtain, neglecting the conduction resistance (for stainless steel, $k=134000[\text{W/m} * \text{°C}]$, $R_{cond}[\text{°C} / \text{W}]$) given by “(57)”.

$$R_{cond} = \frac{t}{k * As} = 6.8 \times 10^{-8} \quad (57)$$

The results are summarized in Table 3.

Table 3
Results

Qcond	2.374	KW
Hfgcorr	2387	KJ/kg
Mcond	0.001	Kg/s
DTlm	15.2	K
UA	156.12	W/K
U	473.4	W/m ² K
Revap	5.18	
Hmean	17371	W/m ² C
Hwater	486.7	W/m ² C

DISCUSSION

The results are based on the assumption of average heat conduction from the vapor and liquid in condensation. However this is not correct at all [2-3-5-6-7-8]. In the condensation process, the overall conduction heat transfer coefficient varies because of the presence of the two phases, vapor and liquid. In order to determine those coefficients, is necessary to know where in the heat exchanger the condensation start, that is, what is the length in the heat exchanger in which the saturation

temperature is reach. This is done in others research by using a thermal paint. In our case, the geometry of the heat exchanger makes this technique very difficult.

The measurements were taken at 8l/min of mass flow rate for cooling water, trying to maintain the condenser exit temperature at 30 C. It was difficult to arrive at steady state conditions. More measurements were taken for the same flow rate of water and the same exit temperature of the condenser. All gives approximate the same results. In order to view the variation of UA at different flow rates, is necessary to run the experiment at different water flow rates, and different condenser exit temperature.

It is clear that for a large mass flow rate (8l/min) of water, a small amount of condensation is obtained (0.001l/s). After reach the saturation temperature in at the condenser, the temperature of the condensation liquid continues to lower until a sub cooler temperature is obtained. The analysis that was made takes in consideration this variation, so the result is a good approximation.

It also can be seen that the conduction resistance is much smaller than the convection resistance. Not take this resistance in consideration do not affect the result of the experiment.

For future studies is recommended to obtain more equipment capable of measure the exact amount of fluid that flows in each circuit in order to make good estimation of the overall conduction coefficient. That is because the amount of condensation in the vacuum side is so small that conventional meters cannot read this flow.

CONCLUSION

For today, the importance of develop new forms of renewable energy is a challenge that all governments should be consider. The develop of solar air conditioning technology will be represent a great challenge due to the sizes absorption machines available today. Studies should be conducted and support by governments and universities.

The study of flat plate heat exchanger offers a great variety of operation conditions that are study for many investigators, but no one have one specific solution for analysis and characterization of a specific use.

The analysis of the condenser was performed on a basis of condensation for a vertical flat plate without corrugations, but a good approximation was obtained. This approximation was chooses due to the lack of information about the heat exchanger geometry. The heat removed in the condenser is acceptable for the designs specifications of a solar air conditioning unit for domestic purpose.

REFERENCES

- [1] Salgado, R., A., "Optimized Solar Cooling Facility Configurations for the Mediterranean Warm Climate", *Doctoral Thesis Universidad Carlos III*, December 2008, retrieved from www.uc3m.es.
- [2] Ayub, Z., "Plate Heat Exchanger Literature Survey and New Heat Transfer and Pressure Drop Correlations for refrigerant evaporators", *Heat Transfer Engineering*, Vol. No. 24(5), 2003, 3-16
- [3] Palm, B., "et al.", "Plate Heat Exchangers: Calculation Methods for Single and Two Phase Flow", *Heat Transfer Engineering*, Vol. No. 27(4), 2006, 88-98
- [4] Izquierdo, M., "Intercambiadores de Calor de Placas", *Universidad Carlos III*, Septiembre 2002, retrieved from www.uc3m.es.
- [5] González, F., "Determinación Experimental del Coeficiente de Convección y el Factor de Fricción de un Intercambiador de Placas", *Universidad Carlos III*, julio 2008, retrieved from www.uc3m.es.
- [6] Gutierrez, G., "Thermo-Fluid Dynamic Evaluation of Components in Adiabatic Absorption System", *Universidad Carlos III*, 2009, retrieved from www.uc3m.es
- [7] Cengel, Y., A., "Heat and Mass Transfer, A Practical Approach", *McGraw Hill*, third edition, 2007, 561-597, 854.
- [8] Palm, B., "et al.", "Plate Heat Exchangers: Calculation Methods for Single and Two Phase Flow", *Heat Transfer Engineering*, Vol. No. 27(4), 2006, 88-98
- [9] Linderburg, M., "Technical Specification for Heat Exchanger 3253K12", *McMaster*, February 2006, retrieved from www.mcmaster.com